

## Flat Nose Pliers - Parallel Action

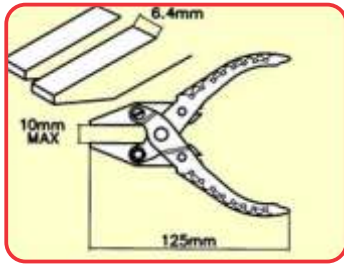

Part No. MAU4870-125  
 125mm Flat Nose Plier  
 Sealed handles  
 Smooth jaws

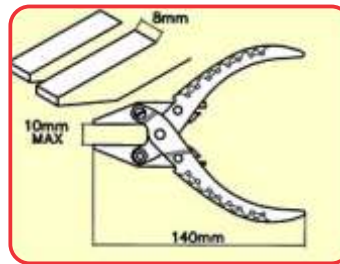

Part No. MAU4870-140mm  
 140mm Flat Nose Plier  
 Sealed handles, smooth jaws

Part No. MAU4870-160mm  
 160mm Flat Nose Plier  
 Sealed handles, smooth jaws

## Side Cutters - Parallel Action

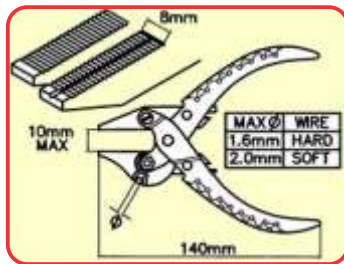

Part No. MAU4950-140  
 140mm Side Cutting Plier  
 Sealed handles  
 Knurled jaws

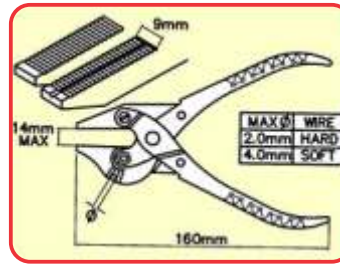

Part No. MAU4950-160  
 160mm Side Cutting Plier  
 Sealed handles  
 Knurled jaws

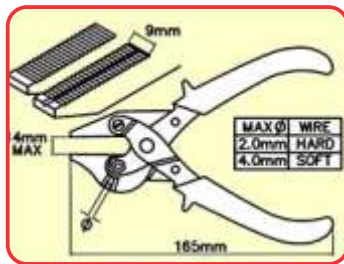

Part No. MAU4960-160  
 160mm Side Cutting Plier  
 PVC Sleeves  
 Knurled Jaws

## Side Cutters

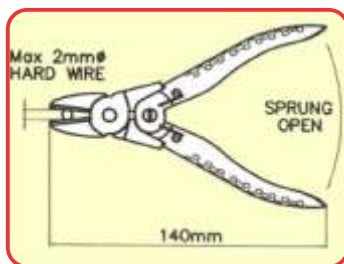

Part No. MAU2990-140B  
 140mm  
 Diagonal Cutting Nipper  
 Spring return

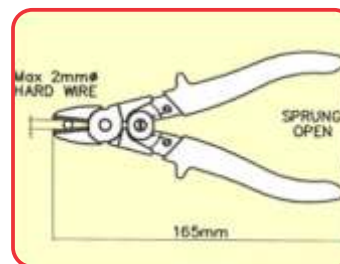

Part No. MAU2990-160B  
 Part No. MAU2990-160  
 160mm  
 Diagonal Cutting Nipper  
 Spring return  
 Plated handles  
 Black jaws

## End Nippers

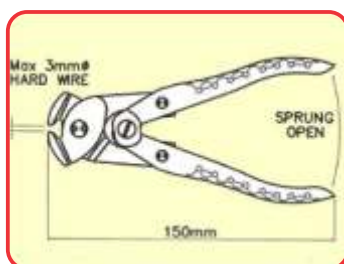

Part No. MAU3010-150  
 150mm End Cutting Nipper  
 Spring return  
 Plated handles  
 Black jaws

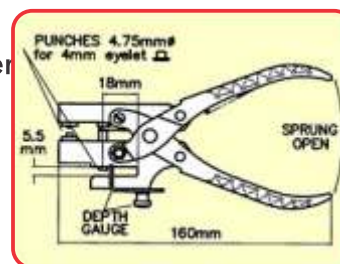

Part No. MAU4570-160  
 160mm Parallel Action  
 Piercing and eyeletting  
 Plier

## Revolving Punch Pliers



Part No. MAU2230-200  
Revolving Punch Plier  
Plated and marked

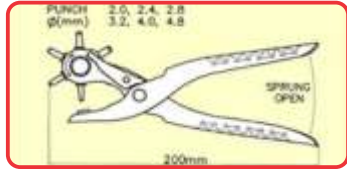

Part No. MAU2240-200  
Universal Punch Plier

## Stationers Punch - Heart

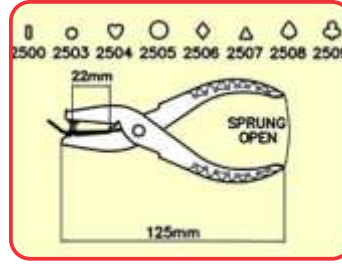

Part No. MAU2504-125  
Stationers Ticket Punch  
Heart

Part No. MAU2506-125  
Stationers Ticket Punch  
Diamond

## Straight Edge Guide

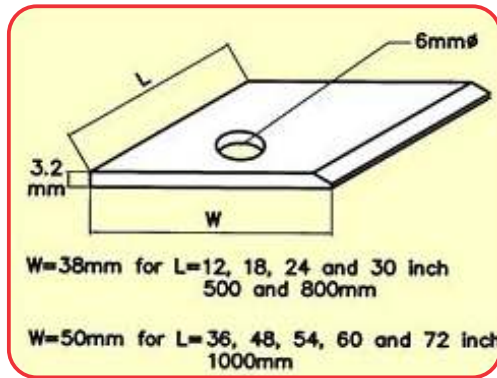

Steel Straight Edge General Purpose

Part No. MAU1700-001 1.0m  
Part No. MAU1701-048 1.2m (48")  
Part No. MAU1701-060 1.5m (60")  
Part No. MAU1701-072 1.8m (72")

Aluminium Straight Edge

Part No. MAU1710-300 300mm

Safety Rule

Part No. MAU1774-300 Length 300mm

## WAD Punches



Handle & Centre Punch

Part No. MAU1000-04

Metric Wad Punch Kit - Part No. MAU1000-05

9 interchangeable punches from 5 - 32mm diameter with handle and centre punch assembly

Wad Punch Cutter

Part No. MAU1000-125 12.5mm Diameter

Spare Punch

Part No. MAU1000-005 5mm  
Part No. MAU1000-006 6mm  
Part No. MAU1000-008 8mm  
Part No. MAU1000-010 10mm  
Part No. MAU1000-016 16mm  
Part No. MAU1000-020 20mm  
Part No. MAU1000-032 32mm

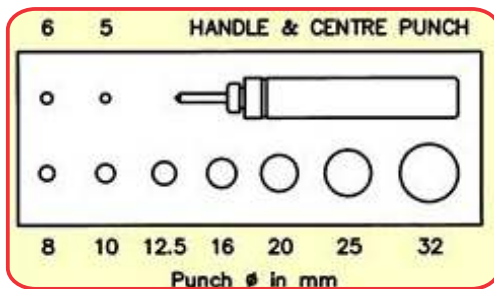

## Meter Sealing Tool



Meter Sealing Tool  
Part No. MAU3278-200